

Wood Applications

Wall Attachment

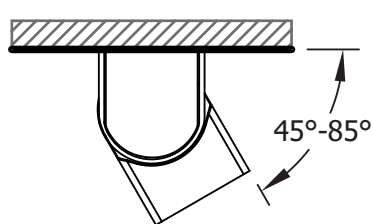

For wall or wood post attachments, use 2 #12 x 2.5" Flat Head Torx screws provided. Ensure adequate backing is provided when mounting brackets.

Tools & Materials Required:

Electric Drill-Torx T25 Bit
or Torx Screw Driver-T25
Measuring Tape

Vista Railing Systems

Toll Free: 800-667-8247 or www.vistarailings.com

Vista™ is a registered trademark of Vista Railing Systems Inc.

Created Mar. 2022 V1

vista[▼]

Universal Angle Bracket Installation Instructions

READ ALL INSTRUCTIONS COMPLETELY BEFORE STARTING INSTALLATION:

It is the responsibility of the installer to meet all code and safety requirements, and to obtain all required building permits. The railing installer should determine and implement appropriate installation techniques for each installation situation. VISTA Railing Systems Inc, its distributors and dealers shall not be held liable for improper or unsafe installations. VISTA Railing Systems posts must always be secured to the sub structure and should never be attached to only the surface material (ie deck board). Failure to follow all of these instructions could result in serious injury or death.

Vista Railing Systems

Toll Free: 800-667-8247 or www.vistarailings.com

STEP 1: Universal Angle Bracket on a Vista Post Mount

Fig 1

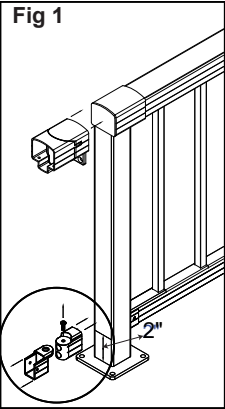

Due to different configuration options, you could use Vista End Post or Vista Blank Post along with a Universal Angle Bracket and/or Post Bracket for your project.

(See Fig 5 for all options)

Top of Universal Angle Bracket to be mounted flush to the top of the Vista Post.

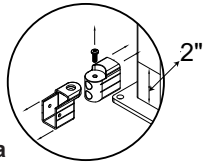

Fig 1a

Separate Bottom Universal Angle Bracket by removing the $\frac{1}{4}$ " x $\frac{3}{4}$ " T25 Torx bolt. Bottom bracket to be located so that the bottom of bracket is 2" up from the base plate.

(See Fig 1a)

STEP 2: Bracket Attachment

Fig 2

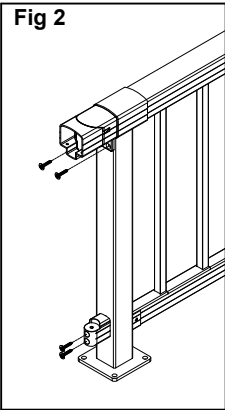

Fasten the Top Universal Angle Bracket to your post by using 2 #12 x 1.25" Torx Tek screws provided with bracket in the fastener package.

Fasten the Bottom Universal Angle Bracket to your post using 2 #12 x 1.25" Torx Tek screws

(See Fig 2)

STEP 3: Bottom Bracket Assembly

Fig 3

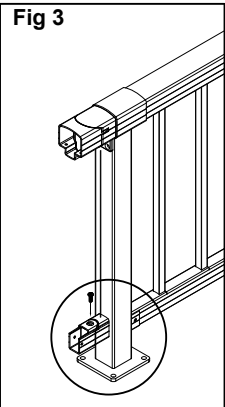

Re-connect bottom bracket together by replacing the $\frac{1}{4}$ " x $\frac{3}{4}$ " T25 Torx bolt. Do not over tighten.

(See Fig 3a)

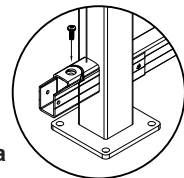
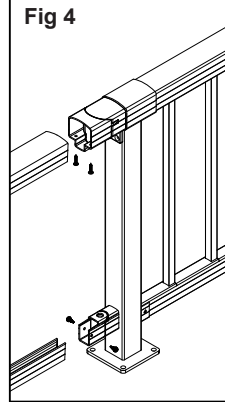

Fig 3a

STEP 4: Top and Bottom Rail Assembly

Fig 4



Install the top rail using 2 #10 x $\frac{3}{4}$ " Torx Tek screws provided with the bracket.

Install the bottom rail using 2 #10 x $\frac{3}{4}$ " Torx Tek screws provided with the bracket.

(See Fig 4)

For complete instructions on top and bottom rail assembly refer to our Residential Deck Railing Assembly Instructions **(Step 4 & 4a)**. These can be found on our website.

Once the top and bottom rails have been installed, tighten the $\frac{1}{4}$ " x $1\frac{3}{4}$ " T25 Torx pivot bolt on the Top Universal Bracket and the $\frac{1}{4}$ " x $\frac{3}{4}$ " T25 Torx pivot bolt on the Bottom Universal Bracket.

FIGURE 5: Bracket and Angle Variations

End Post

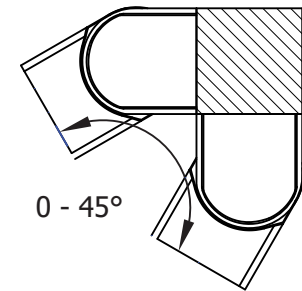
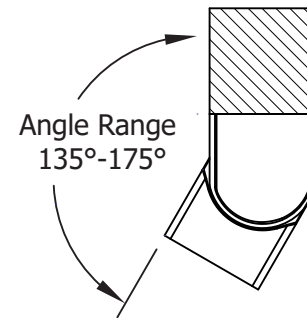

Post Bracket

Blank Post

