

**SECTION A-A**

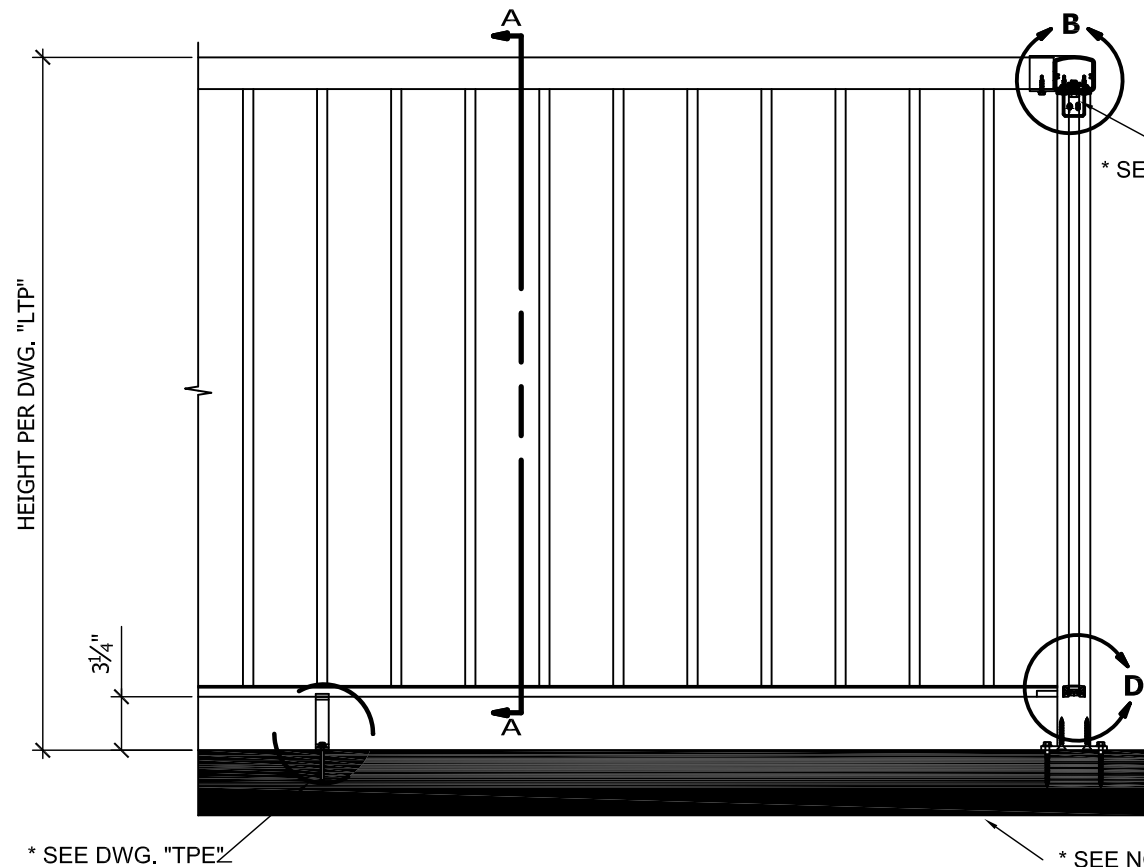

**ELEVATION**

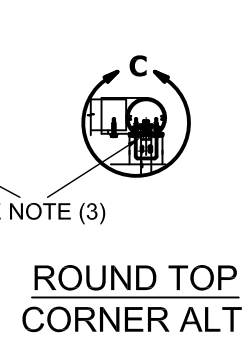

**ROUND TOP CORNER ALT.**

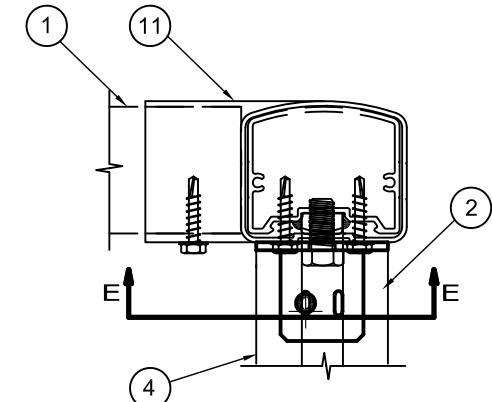

**DETAIL 'B' SQUARE TOP CORNER**

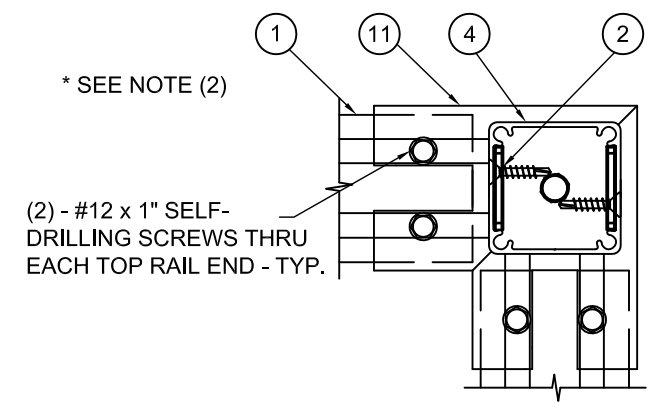

**SECTION E-E**

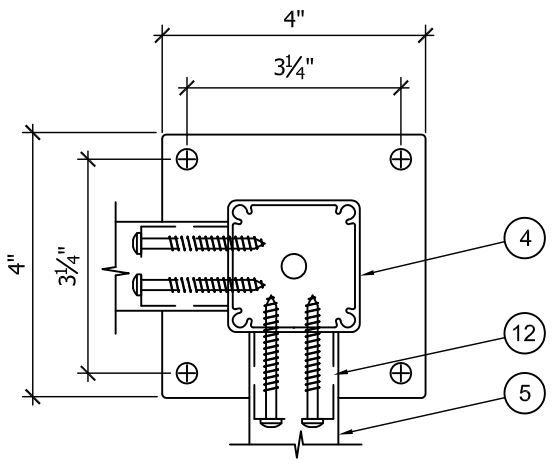

**SECTION F-F**

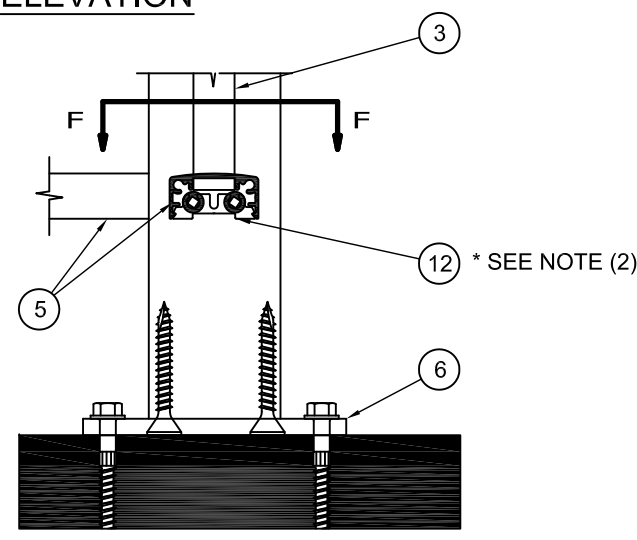

**DETAIL 'D' BOTTOM CORNER**

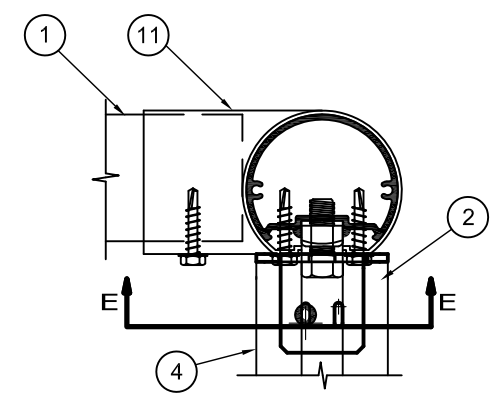

**DETAIL 'C' ROUND TOP CORNER**

PARTS LIST	
ITEM	DESCRIPTION
1	2 1/4" SQUARE □ OR ROUND TOP □ RAIL (CHECK CORRECT BOX)
2	RAIL/POST CONNECTOR C/W 3/8" Ø NUT AND BOLT TO RAIL & (2) - #10 X 1" SCREWS TO POST
3	5/8" X 5/8" ALUMINUM PICKET
4	2" STANDARD ALUMINUM POST
5	1 3/8" X 3/4" BOTTOM CHANNEL
6	4" X 4" X 1/4" BASE C/W (4) - 5/16" Ø X 3 1/4" LAG SCREW INTO WOOD OR (4) - 3/8" Ø X 3" KWIK BOLTS II ANCHORS INTO CONCRETE AND TO POST W/ (4) - #12 X 2" FLAT HEAD SCREWS
7	PICKET LEG C/W 1/4" Ø X 2 1/2" SCREW INTO WOOD OR #14 X 2" "TAPCON" ANCHOR INTO CONCRETE
8	(NOT SHOWN)
9	(NOT SHOWN)
10	(NOT SHOWN)
11	TOP RAIL EXTERNAL CORNER SLEEVE
12	CHANNEL BLOCK C/W (2) - #10 X 1 3/4" SCREWS TO POST

**NOTES:**  
 (1) BUILDING GENERAL CONTRACTOR IS RESPONSIBLE FOR PROVIDING ADEQUATE BACKING IN WALLS AND FLOORS TO AFFIX TO THE BUILDING THE ALUMINUM GUARDRAIL LAYOUT DEFINED IN THESE DRAWINGS  
 (2) ITEM #1 FITS INSIDE ITEM #11 ; ITEM #2 FITS INSIDE ITEM #4 ; ITEM #12 SNAPS INSIDE ITEM #5  
 (3) WELD PICKET TO UNDERSIDE OF TOP OF PART #1 OR #5

Manufactured by...  
**vista pro**  
 23282 River Road, Maple Ridge, BC, Canada, V2W 1B6  
 Phone: 604-467-5147 info@vistarailings.com  
 Fax: 604-467-1197 www.vistarailings.com

PROJECT:  
**PROJECT NAME**  
 CLIENT:  
**CLIENT NAME**

LOCATION:  
**ADDRESS**  
**CITY**

ALUMINUM GUARDRAILS			
DRAWN	RK	PROJECT No	YEAR / No
DESIGNED	RDH	CHECKED	RDH
SCALE	NTS	CHECKED	DATE

PLEASE NOTE: These drawings are for general guidelines only and are not stamped engineered shop drawings. It is important that for any project or site specific applications and requirements, shop drawings must be created and stamped by a Professional Engineer.

**TOP MOUNT 2.0 POST PICKET GUARD CORNER**  
 DRAWING No **TPC2.0**